

**VENSTAR®**

**RESIDENTIAL  
THERMOSTAT  
T5800**

**HIGH RESOLUTION  
DIGITAL THERMOSTAT**

**ColorTouch™**



**FULL  
COLOR  
TOUCH  
SCREEN  
DISPLAY**



**OWNER'S  
MANUAL  
AND  
INSTALLATION  
INSTRUCTIONS**



### CAUTION

Follow the Installation Instructions before proceeding.  
Set the thermostat mode to "OFF" prior to changing  
settings in setup or restoring Factory Defaults.

---

This device complies with Part 15 of the FCC Rules. Operation is subject to the following two conditions: (1) this device may not cause harmful interference, and (2) this device must accept any interference received, including interference that may cause undesired operation.

---

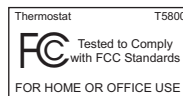

## Glossary of Terms

**Auto-Changeover:** A mode in which the thermostat will turn on the heating or cooling based on room temperature demand.

**Cool Setpoint:** The warmest temperature that the space should rise to before cooling is turned on (without regard to deadband).

**Deadband:** The number of degrees allowed past setpoint, before energizing heating or cooling.

**Differential:** The forced temperature difference between the *heat setpoint* and the *cool setpoint*.

**Heat Setpoint:** The coolest temperature that the space should drop to before heating is turned on (without regard to deadband).

**Icon:** The word or symbol that appears on the thermostat display.

**Mode:** The current operating condition of the thermostat (i.e. Off, Heat, Cool, Auto, Program On).

**Non-Programmable Thermostat:** A thermostat that does not have the capability of running *Time Period Programming*.

**Programmable Thermostat:** A thermostat that has the capability of running *Time Period Programming*.

**Temperature Swing:** *Same as Deadband.*

**Time Period Programming:** A program that allows the thermostat to automatically adjust the *heat setpoint* and/or the *cool setpoint* based on the time of the day. *Same as Schedule.*

## Table of Contents

### **Get to Know Your Thermostat**

- 1** Home Screen
- 1** Menu Screens
- 2** Care and use of your thermostat

### **Quick Start**

- 3** Selecting your desired temperature and mode
- 3** Using the Fan button
- 5** Setting the time
- 6** Setting the date
- 6** Daylight Savings setup

### **The Main Menu Buttons**

- 7** **Schedule**
- 8** Time Period Schedule On/Off
- 8** View My Schedule
- 8** Edit My Schedule
- 10** **Smart Fan**
- 11** Smart Fan On/Off
- 11** Smart Fan Minimum Runtime
- 11** Start/Stop Times
- 11** Days to allow Smart Fan operation.
- 12** **Screensaver**
- 13** Screensaver On/Off
- 13** Screensaver Setup
- 13** Screensaver Preview
- 14** **Alerts**
- 15** View Current Alerts
- 15** Reset Alerts
- 15** Set/Edit Reminders
- 15** Service Information (Who To Call For Service)

## Table of Contents

<b>16</b>	<b><u>Display</u></b>
<b>17</b>	Active Brightness
<b>17</b>	Idle Brightness
<b>17</b>	Night Dimmer
<b>18</b>	Maintenance
<b>19</b>	<b><u>Preferences</u></b>
<b>20</b>	User Interface Themes
<b>20</b>	Custom Wallpaper
<b>20</b>	Heat/Cool Indicator
<b>20</b>	Backdrop On/Off
<b>20</b>	Sound Options
<b>21</b>	<b><u>Vacation</u></b>
<b>22</b>	Vacation Mode On/Off
<b>22</b>	Schedule
<b>23</b>	Modes & Setpoints
<b>24</b>	<b><u>Security</u></b>
<b>25</b>	Auto Screenlock
<b>25</b>	Setpoint Limits
<b>25</b>	Mode Restrictions
<b>26</b>	<b><u>Information</u></b>
<b>27</b>	Who To Call For Service
<b>27</b>	View Runtime Graphs
<b>28</b>	<b><u>Settings</u></b>
<b>31</b>	Thermostat Name
<b>31</b>	Available Modes
<b>31</b>	SD Card (Import and Export)
<b>31</b>	<b><u>General Setup</u></b>
<b>31</b>	Units (F or C)
<b>32</b>	Language
<b>32</b>	Smart Recovery ON/OFF
<b>32</b>	Simple Thermostat ON/OFF
<b>33</b>	<b><u>Installation Settings</u></b>
<b>33</b>	<b><u>Heat &amp; Cool Stages</u></b>
<b>33</b>	Heat & Cool Stages
<b>33</b>	Compressor Stages
<b>33</b>	Aux Heat Stages

## Table of Contents

	<u>Installation Settings (continued)</u>
<b>33</b>	Timers & Deadbands
<b>35</b>	Free Cooling
<b>36</b>	<u>Heat Pump Settings</u>
<b>36</b>	Heat Pump Lockout - Enabled/Disabled
<b>36</b>	Heat Pump Lockout Outdoor Temp
<b>36</b>	Aux Heat Lockout Enabled/Disabled
<b>36</b>	Aux Heat Lockout Temp
<b>36</b>	<u>Dual Fuel Settings</u>
<b>36</b>	Dual Fuel On/Off
<b>36</b>	Changeover With Outdoor Temp On/Off
<b>36</b>	Adjust Balance Point
<b>37</b>	Fan Off Delay
<b>37</b>	Calibrate Sensors
<b>37</b>	Test Outputs
<b>38</b>	Dealer Information
<b>38</b>	Reset To Factory Default Settings
<b>38</b>	Upgrade Firmware
<b>39</b>	<u>Emergency Heat</u>
<b>40</b>	<u>ColorTouch Assistant</u>
<b>40</b>	Installing the ColorTouch Assistant Software
<b>41</b>	Uploading Photos
<b>42</b>	<u>Installation Instructions</u>
<b>42</b>	Remove & Replace the Old Thermostat
<b>43</b>	Wire Connections
<b>44</b>	The Color Touch Thermostat Backplate
<b>45</b>	Explanation Of the Thermostat Dip Switches
<b>46</b>	Sample Wiring Diagrams
<b>49</b>	<u>Troubleshooting</u>
<b>50</b>	<u>Index</u>
<b>56</b>	<u>Warranty</u>

# Get To Know Your Thermostat

## Home Screen

**Backlit Color Touchscreen Display** **Outdoor Temperature**  
 With high & low temps for the day  
 (If optional sensor is installed)

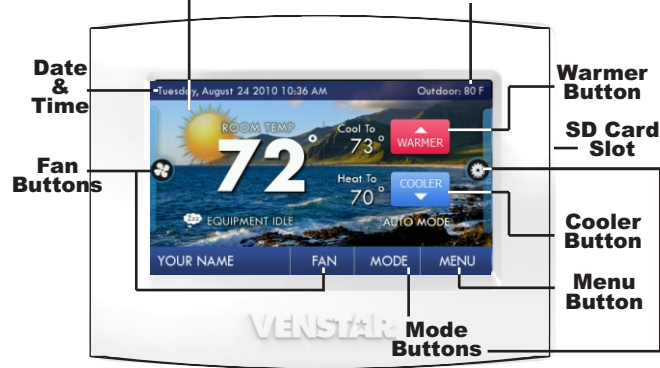

## Main Menu Screen

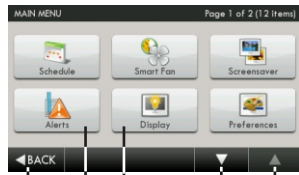

**Back Button**  
**Menu Buttons**  
**Scrolling Buttons**

## Sub Menu Screen

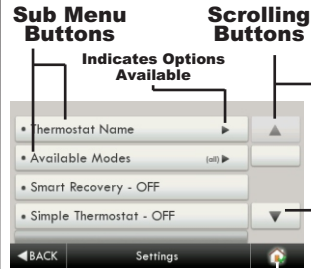

**Sub Menu Buttons**  
**Scrolling Buttons**  
 Indicates Options Available  
**Home Button**

## Get To Know Your Thermostat

### Care and Use of Your Thermostat

Pencils, pens and other sharp objects should never be used on your ColorTouch™ thermostat; these may damage your touchscreen. Only use your finger tip to press the touchscreen buttons.



Use a soft, damp cloth to clean the screen.

**DO NOT USE ABRASIVE CLEANERS OR CLEANERS THAT CONTAIN SOLVENTS. DO NOT SPRAY ANYTHING DIRECTLY ONTO THE THERMOSTAT.**

## Quick Start



## Temperature, Modes & Fan

### Selecting Your Desired Temperature and Mode

Press  or  to adjust temperature

The Heat or Cool Setpoint is the temperature the room has to reach before heating or cooling will turn on.  
(Without regard to deadband)



Press  or the MODE Icon 



HEAT will allow only heat operation.

COOL will allow only cool operation.



AUTO will allow both Heat and Cool operation.

OFF - heating and cooling systems are turned off.

**AUTO-CHANGEOVER MODE** - Pressing the WARMER or COOLER buttons in Auto mode will adjust **both** the heat and cool setpoints simultaneously. To adjust heat and cool setpoints individually, choose HEAT mode to adjust the heat setpoint and COOL mode to adjust the cool setpoint, then return to AUTO mode.

**HEAT OR COOL MODE** - Pressing the WARMER or COOLER buttons in Heat or Cool mode will adjust only the heat **or** cool setpoints.

### Using the Fan Button

Press  or the FAN Icon 

FAN ON fan runs constantly even in OFF Mode.

FAN AUTO fan only runs with a heating or cooling demand.

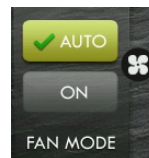

**Quick Start** **Set Time & Date**



- Set Current Time ▶
- Use AM/PM - ON
- Set Current Date ▶
- Daylight Savings Setup ▶
  - Daylight Savings Time - OFF ▶
  - Start Schedule ▶
    - Starts On (2nd) ▶
    - Day (Sun) ▶
    - Month (March) ▶
  - Stop Schedule ▶
    - Ends On (1st) ▶
    - Day (Sun) ▶
    - Month (November) ▶

### Setting the Time

Press **MENU** then  to scroll down.



Press  **Set Time & Date**

Press  **Set Current Time** (12:00 AM)  

Press  **hr +** and  **min +**  
 **hr -** and  **min -** to set the current time.

Press  **BACK** when finished.

Choose

 **Use AM/PM - ON**    
For 12 hour AM/PM clock

 **Use AM/PM - OFF**   
For 24 hour clock

Press  **BACK** when finished.

## Quick Start

## Set Time & Date

### Setting the Date

• Set Current Date 7/8/2010 ▶ Press

Press ◀ or ▶ to set the current month and year.

Press the day on the calendar

Su	Mo	Tu	We	Th	Fr	Sa
27	28	29	30	1	2	3
4	5	6	7	8	9	10
11	12	13	14	15	16	17
18	19	20	21	22	23	24
25	26	27	28	29	30	31
1	2	3	4	5	6	7

Press ◀ ▶

Press ◀ BACK when finished.

### • Daylight Savings Setup ▶

Turn Daylight Savings Time on or off.

- Daylight Savings Time - OFF
- Daylight Savings Time - ON ✓

Adjust when Daylight Savings Time begins.

• Start Schedule ▶

• Starts On (2nd) ▶

• Day (Sun) ▶

• Month (March) ▶

Adjust when Daylight Savings Time ends.

• Stop Schedule ▶

• Ends On (1st) ▶

• Day (Sun) ▶

• Month (November) ▶

Press ◀ BACK after making a change to a selection.

Press ◀ BACK or the Home button when finished.

**The Main Menu Buttons** Schedule



- Time Period Schedule - OFF
- View My Schedule ▶
- Edit My Schedule ▶

## The Main Menu Buttons

## Schedule



Schedule

This thermostat features up to four programmable time periods per 24 hour day: Morning, Day, Evening, and Night. The start time for each time period is adjustable. The stop time for each time period is the start time for the next period.

Press to turn Schedule On or Off

• Time Period Schedule - OFF

• Time Period Schedule - ON ✓

• View My Schedule ▶

Press a day of the week to view its settings. This may be repeated for each day.



• Edit My Schedule ▶

Press and select day(s) to program

Select individual day(s)

or

Select groups of day(s)

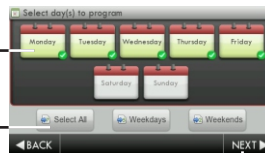

Then press NEXT

**The Main Menu Buttons** **Schedule**

• **Edit My Schedule** ▶ (Continued)

Press and select a Time Period (Morning, Day, Evening, or Night) to edit.



Adjust Mode, Start Time, and Heat and Cool Setpoints to desired settings. The Time Period may also be Enabled or Disabled. Un-check the Enabled box for Time Periods you don't want to use. Press **DONE** when finished.

**TIP:** For a simpler schedule that only uses 2 time periods, un-check Enabled for Day and Evening Time Periods.

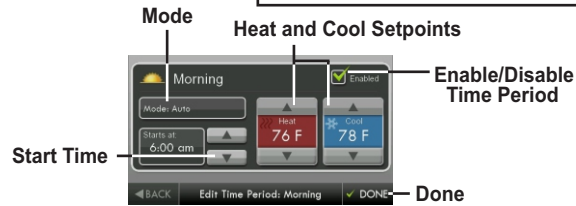

When you are finished editing the four time periods press **NEXT** ▶

Review your program. Press **SAVE** to keep your program. Press **EDIT** to make further changes.

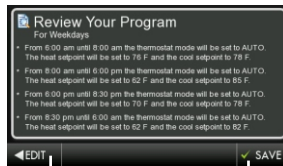

**The Main Menu Buttons** Smart Fan

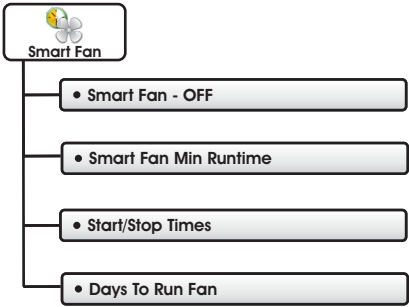

## The Main Menu Buttons

Smart Fan



The fan may be programmed to turn on automatically for a specified period during the day.

Press to turn fan schedule on or off

• Smart Fan - OFF

• Smart Fan - ON



• Smart Fan Min Runtime (10m) ▶

Set the minimum number of minutes the fan will run from the top of each hour. Set runtime to 60 minutes to be on continuously from Start Time to Stop time. (5 - 60 mins.)

• Start/Stop Times (7:00AM - 9:00PM) ▶

Set when the Smart Fan schedule will start and stop. For example, you may not want Smart Fan to run during sleeping hours.

• Days To Run Fan ▶

Choose which days of the week Smart Fan will run.

**The Main Menu Buttons** Screensaver

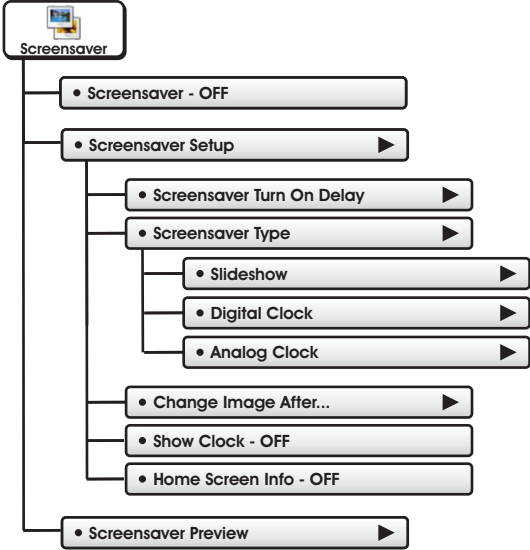

## The Main Menu Buttons Screensaver



The Screensaver allows you to create custom slideshows.

• Screensaver - OFF

• Screensaver - ON



• Screensaver Setup ▶

• Screensaver Turn On Delay (5m) ▶

How long after a button press for the Screensaver to appear.  
1, 3, 5, or 30 minutes

• Screensaver Type (Slideshow) ▶

Slideshow  
Digital Clock  
Analog Clock

• Change Image After... ▶

15, 30 seconds - 1, 5, or 10 minutes

• Show Clock - OFF ▶

Shows the time and date every 5 photos. Off or On

• Home Screen Info - OFF ▶

Shows the mode, setpoints, and temperature after every 10 photos. Off or On.

• Screensaver Preview ▶

Press this button to preview your screensaver operation before returning to the Home Screen.

After the preview, press anywhere on the screen to return to the sub menu.

**The Main Menu Buttons Alerts**

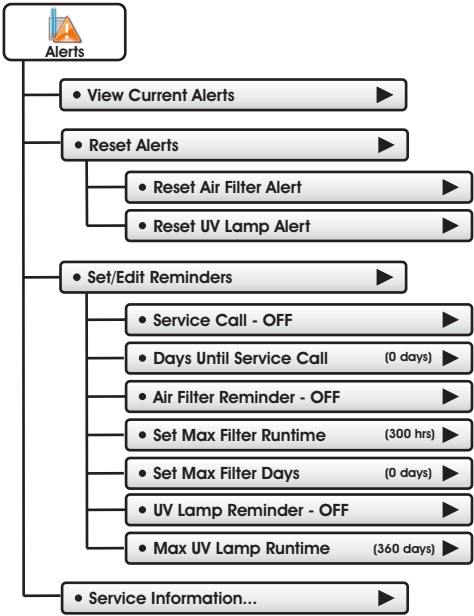

**The Main Menu Buttons Alerts**



The alerts let you know when your system needs service.

**• View Current Alerts**

View and reset current service alerts here.



Alerts will appear on the bottom bar of the Home Screen. Press to view and reset current alerts.



**• Reset Alerts**

Clear and reset current service alerts.

**• Set/Edit Reminders**

Set service alert runtimes and turn reminders on or off.

- Service Call Reminder - OFF
- Days Until Service Call (0 days)
- Air Filter Reminder - OFF
- Set Max Filter Runtime (500 hrs)
- Set Max Filter Days (300 days)
- UV Lamp Reminder - OFF
- Set Max UV Lamp Runtime (300 days)

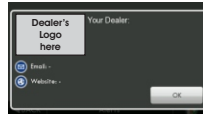

**• Service Information...**

View your service company's contact information.

**The Main Menu Buttons** Display

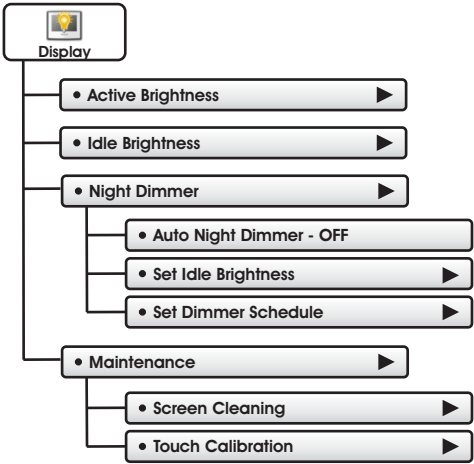

## The Main Menu Buttons

Display



Display

The display brightness options may be adjusted in this menu.

• **Active Brightness** (80%) ▶

You may select how bright the backlight is while the thermostat is active. The display is active for 3 minutes after last touch, it then goes Idle.

• **Idle Brightness** (30%) ▶

You may select how bright the backlight is while the thermostat is idle.

• **Night Dimmer** ▶

You may dim the brightness of the ColorTouch screen at night.

• **Auto Night Dimmer - OFF**

The screen can be set to dim automatically at night. Dimming the display can prolong the life of the backlight.

• **Set Idle Brightness** (50%) ▶

Set the screen brightness for the Night Dimmer. When Night Dimmer is On, the display will go idle after 8 seconds after last touch.

• **Set Dimmer Schedule** ▶

Set the schedule for the Night Dimmer.

## The Main Menu Buttons

Display

### • Maintenance ▶

Maintenance allows you to clean and calibrate the ColorTouch Screen.

### • Screen Cleaning ▶

Screen Cleaning Mode disables the touch feature for 20 seconds so the screen may be cleaned without altering any settings.



Use a soft cloth without solvents or abrasive cleaners

### • Touch Calibration ▶

Under normal circumstances, the ColorTouch touchscreen should not need to be calibrated.

Touch the center of the targets as they appear on the screen.

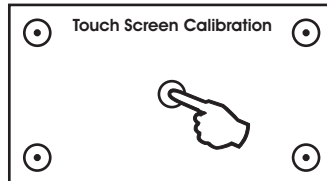

Press **FINISH** when done.

When calibration is complete, the thermostat will automatically restart and return to the Home Screen.

**The Main Menu Buttons** Preferences

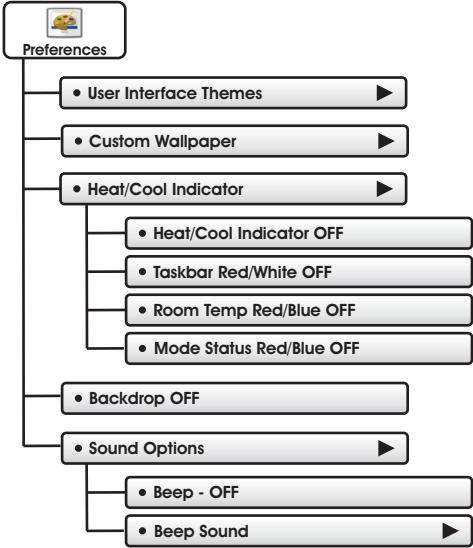

## The Main Menu Buttons

## Preferences



### Preferences

You may set the type of background that appears on the thermostat Home Screen.

#### • User Interface Themes (ocean) ▶

This thermostat has several high quality background themes to choose from. **NOTE:** At 7 PM, the background will change to an evening scene and the moon will replace the sun. At 6 AM it will return to a daytime scene.

#### • Custom Wallpaper ▶

You may choose your own background image by selecting a photo that you have uploaded from an SD memory card.

#### • Heat/Cool Indicator ▶

You may choose an enhanced indicator of the current status of the HVAC equipment.

- Heat/Cool Indicator - ON/OFF
- Room Temp Red/Blue - ON/OFF
- Taskbar Red/White - ON/OFF
- Mode Status Red/Blue - ON/OFF

#### • Backdrop - OFF

#### • Backdrop - ON

The Backdrop makes numbers and words easier to read, and may be needed on certain background images.

#### • Sound Options ▶

#### • Beep - ON

#### • Beep - OFF

Turn the beep sound on or off.

#### • Beep Sound (Beep 1) ▶

Choose from different beep sounds.

**The Main Menu Buttons** Vacation

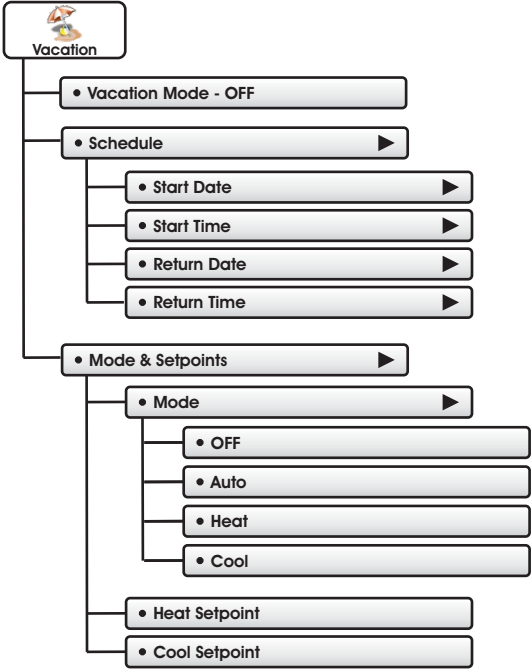

## The Main Menu Buttons

Vacation



Vacation may use temporary, energy saving settings without changing the regular schedule.

### • Vacation Mode - OFF

Vacation Mode must be OFF to change Schedule, Mode and Setpoint settings.

### • Schedule

Set your Vacation Schedule.

#### • Start Date

Tue Sep 07 2010

Select the day Vacation Mode will start.

Then press **BACK**



**BACK**

#### • Start Time

(9:00 AM)

Select the time Vacation Mode will start.

Then press **BACK**

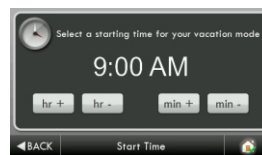

## The Main Menu Buttons

## Vacation

### • Schedule

(Continued)

#### • Return Date Tue Sep 21 2010

Select the day Vacation Mode will end.

Then press **BACK**



#### • Return Time (3:00 PM)

Select the time Vacation Mode will end.

Then press **BACK**

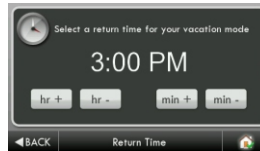

### • Modes & Setpoints

Select the desired Mode and setpoints to be used in Vacation Mode.

#### • Mode (Auto)

#### • Heat Setpoint (50°)

#### • Cool Setpoint (85°)

### • Vacation Mode - OFF

### • Vacation Mode - ON

Turn Vacation Mode ON. The Time Period Schedule must be ON to use Vacation Mode. (See Schedule in the Main Menu)

**The Main Menu Buttons** Security

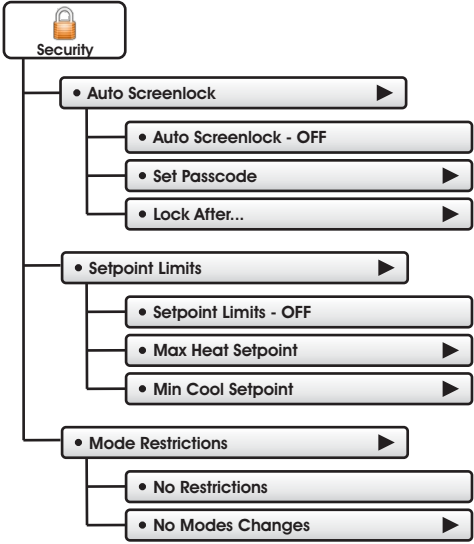

**The Main Menu Buttons** **Security**



Security settings may be set to limit or prevent changes to your thermostat.

• **Auto Screenlock** ▶

- Auto Screenlock - OFF
- Auto Screenlock - ON ✓

NOTE: Code must be set before Auto Screenlock can be turned on.

• **Set Passcode** (code not set) ▶

Use keypad to enter and confirm passcode.

\* If you forget your passcode, enter 6736 for access.



When the thermostat is locked, the bottom bar of the display will show:



Press **UNLOCK** then enter passcode to access thermostat settings.

• **Lock After...** (5 m) ▶

Set the time the screen will automatically lock after the last button press.

• **Setpoint Limits** ▶

Limits how high or low heating and cooling may be adjusted.

• **Mode Restrictions** ▶

Limits which thermostat Modes are used.

**The Main Menu Buttons** Information

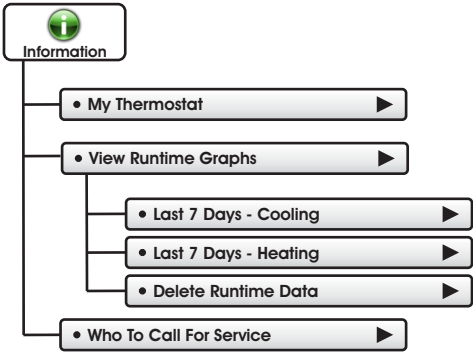

**The Main Menu Buttons** **Information**



This button contains valuable service and system runtime information.

**• My Thermostat** ▶

View your thermostat dip switch settings, equipment status, runtimes, and other settings.

**• View Runtime Graphs** ▶

Track your system's runtime/energy usage.

**• Last 7 Days - Cooling** ▶

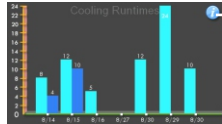

Press the information icon to learn more about each graph

**\*NOTE:** The runtime graphs are updated at 12:00 AM each day.

**• Last 7 Days - Heating** ▶

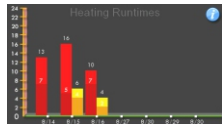

Press anywhere on the screen to return to the submenu.

**• Delete Runtime Data** ▶

Press to delete your current equipment runtime information.

**• Who To Call For Service** ▶

Your service company's contact information is displayed here.



**The Main Menu Buttons** Settings

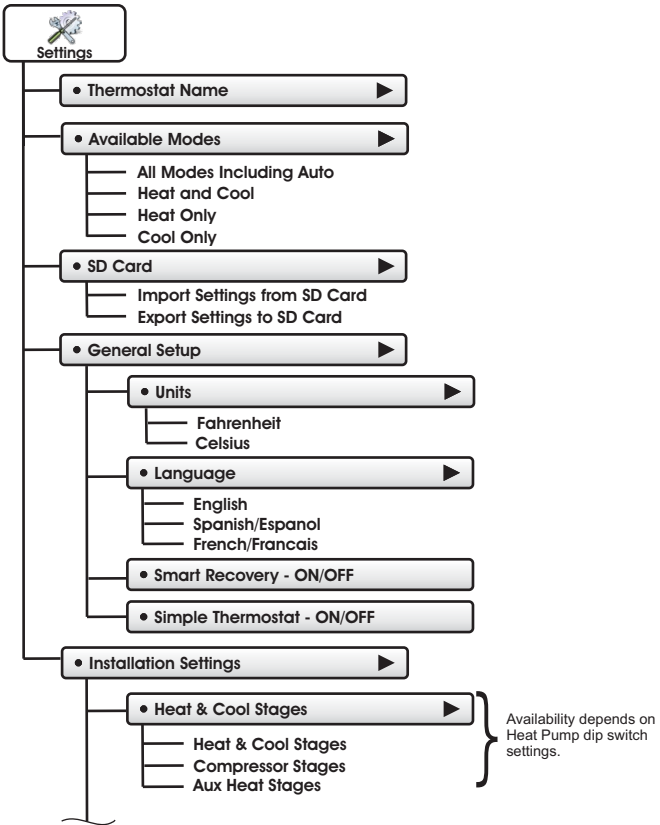

Availability depends on Heat Pump dip switch settings.

(Continued next page)

**The Main Menu Buttons** Settings



• Installation Settings ▶ (Continued)

• Timers & Deadbands ▶

- Cycles Per Hour
- Min Heat/Cool Difference
- Compressor Min Off Time
- 1st Stage Deadband
- 2nd Stage Deadband
  - 2nd Stage Deadband
  - 2nd Stage Timer
  - 2nd Stage Turnoff Point
    - Deadband
    - Setpoint
- 3rd Stage Deadband
  - 3rd Stage Deadband
  - 3rd Stage Timer
  - 3rd Stage Turnoff Point
    - Deadband
    - Setpoint
- 4th Stage Deadband
  - 4th Stage Deadband
  - 4th Stage Timer
  - 4th Stage Turnoff Point
    - Deadband
    - Setpoint

• Free Cooling ▶

- Free Cooling - On/Off
- Usable Outdoor Temp
- Mechanical Cooling? - Yes/No

(Continued next page)

**The Main Menu Buttons** **Settings**

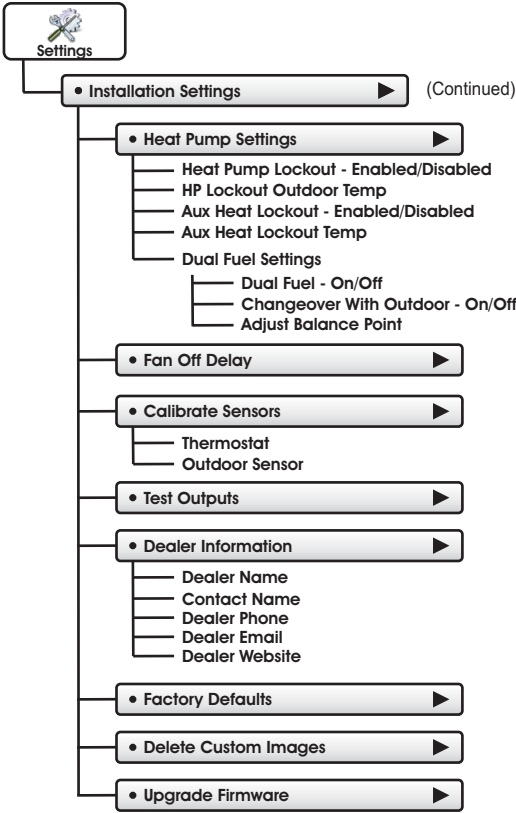

## The Main Menu Buttons

## Settings



Thermostat heating and cooling options are found in this menu

### • Thermostat Name ▶

Use keypad to name your thermostat. The name is displayed on the Home Screen.

(Up to 14 characters)

Name appears here



### • Available Modes (all) ▶

Choose the desired modes the thermostat will use: Heat, Cool, Heat & Cool, or Auto (All). For example, if you only have a heater, choose Heat, and only Heat & Off modes will be available. This will simplify the operation for the user.

### • SD Card ▶

Import and export files to and from the thermostat. See the **ColorTouch Assistant** instructions for further details.

#### • Import Settings from SD Card ▶

Upload files from ColorTouch Assistant or another thermostat.

#### • Export Settings to SD Card ▶

Export files from one thermostat and import them into others.

**\*NOTE:** SD cards with 20 MB minimum capacity required. To import and export files, the SD card must contain the same version of the firmware as the thermostat.

### • General Setup ▶

#### • Units (F) ▶

- Fahrenheit (F)
- Celsius (C)

**The Main Menu Buttons** Settings

• **General Setup** ▶ (Continued)

• **Language** (en) ▶

- English
- Spanish/Espanol
- French/Francais

• **Smart Recovery - OFF**

• **Smart Recovery - ON** ✓

Smart Recovery turns on the heat before the Morning start time to bring the room temperature to the Morning setpoint at the start of the Morning time period. Please allow 4-8 days for Smart Recovery time to adjust. When used with a heat pump, electric strip heat will be disabled while Smart Recovery is active.

• **Simple Thermostat - OFF**

• **Simple Thermostat - ON** ✓

**Turn on Simple Thermostat for the most basic user interface.**

When Simple Thermostat is on, alerts will appear in the top bar of the main screen. Press on the top yellow alert bar to view alerts.



**The Main Menu Buttons** Settings

• **Installation Settings** ▶

• **Heat & Cool Stages** (1h1c) ▶

• **Heat & Cool Stages** (1h1c) ▶

Up to 2 Stages Cooling and 4 stages Heating.

• **Compressor Stages** (1h1c) ▶

Up to 2 compressors.

• **Aux Heat Stages** (1h1c) ▶

0 to 2 stages of Aux Heating.

} Only available when dip switch is set for Heat Pump operation.

• **Timers & Deadbands** ▶

• **Cycles Per Hour** (6) ▶

At 6 cycles per hour, the HVAC unit will only be allowed to energize once every 10 minutes. The Cycles Per Hour limit may be overridden and reset by pressing the WARMER or COOLER buttons.  
(2, 3, 4, 5, 6, No Limit)

• **Min Heat/Cool Difference** (2°) ▶

The minimum gap between Heat and Cool setpoints. (0 - 6 deg. F)

• **Compressor Min OFF Time** (5m) ▶

None, 1 minute, or 5 minutes.

**The Main Menu Buttons** **Settings**

• **Installation Settings** ▶ (Continued)

• **Timers & Deadbands** ▶ (Continued)

**The Deadband is the number of degrees or minutes that the thermostat waits before it initiates the stages of heating or cooling.**

**1st Stage Deadband** Specifies the minimum temperature difference between the room temperature and the desired setpoint before the first stage of heating or cooling is allowed to turn on. For example, if the heat setpoint is 68 and the 1st Stage deadband is set to 2 degrees, the room temperature will need to drop to **66 degrees** before the heat turns on.

• **1st Stage Deadband** (2°) ▶

(1 - 6 deg. F)

• **2nd Stage Deadband** ▶

• **2nd Stage Deadband** (2°) ▶

Number of degrees past 1st stage before 2nd stage turns on. (0 - 10 deg. F)

• **2nd Stage Timer** (2mins) ▶

Number of minutes past 1st stage before 2nd stage turns on. (0 - 60 mins.)  
(The 2nd stage deadband must also be met)

• **2nd Stage Turnoff Point** (Deadband) ▶

Deadband or Setpoint.

• **3rd Stage Deadband** ▶

• **4th Stage Deadband** ▶

3rd and 4th stage  
deadband settings  
are the same as  
2nd stage.

**The Main Menu Buttons** **Settings**

• Installation Settings ▶ (Continued)

• Free Cooling ▶

Free Cooling is an energy saving way to boost the efficiency of your air conditioning system by bringing in cool air from the outside. The installation of a Free Cooling damper(s) and outdoor temperature sensor is required.

• Free Cooling - DISABLED

• Free Cooling - ENABLED ✓

Turns on Free Cooling.

• Usable Outdoor Temp (65°) ▶

Free Cooling shuts off above this outdoor temperature. (40 - 80 degrees F)

• Mechanical Cooling? - NO

• Mechanical Cooling? - YES ✓

If you don't have a compressor, set Mechanical Cooling to "NO", Y1 will then be used to control the Free Cooling Damper(s) and Y2 will be disabled. If set to "YES", mechanical (compressor) cooling will be controlled by the Y2 terminal. (See page 48 for wiring diagram)

Mechanical air conditioning is turned on with a 2nd stage demand for cooling and the Free Cooling, outdoor air damper is closed.

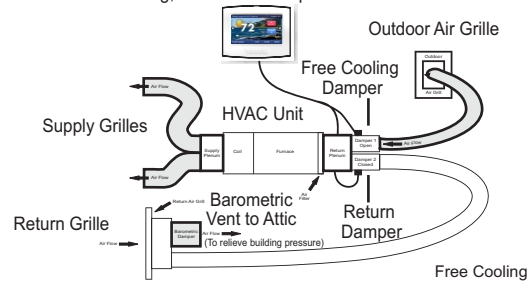

## The Main Menu Buttons Settings

• Installation Settings ▶ (Continued)

• Heat Pump Settings ▶

(Only available when dip switch is set for Heat Pump operation.)

• Heat Pump Lockout - DISABLED ▶

• Heat Pump Lockout - ENABLED ✓

Turns on Heat Pump Lockout.

• HP Lockout Outdoor Temp (65°) ▶

Heat Pump will not run below this temp. (20 - 75 deg. F)

• Aux Heat Lockout - DISABLED ▶

• Aux Heat Lockout - ENABLED ✓

Turns on Aux Heat Lockout.

• Aux Heat Lockout Temp (65°) ▶

Aux Heat will not run above this temp. (20 - 75 deg. F) **GAS/EL or HP** dip switch must be set for **HP** and **GAS or ELEC** dip switch must be set for **ELEC**.

• Dual Fuel Settings ▶

*This feature is for heat pump applications only.*

This will only appear if the **GAS/EL or HP** dip switch is set for **HP** and the **GAS or ELEC** dip switch is set for **Gas**.

**When Dual Fuel is ON**, an outdoor temperature or a demand for third stage heat will be used to stop running the heat pump and switch to a fossil fuel source of heat. **NOTE:** Once the change to fossil fuel is made, the heat demand must finish with fossil fuel. Additional heat demands within 10 minutes will also use fossil fuel, regardless of outdoor temperature or stage demand.

- **Dual Fuel - ON/OFF**
- **Changeover With Outdoor - ON/OFF**  
Uses outdoor sensor for changeover.
- **Adjust Balance Point**  
Choose the temperature for changeover to fossil fuel. (5 - 60 deg. F)

## The Main Menu Buttons

Settings

• Installation Settings ▶ (Continued)

• Fan Off Delay (0s) ▶

Runs the fan for a short time after Cooling or electric strip heat turns off to increase system efficiency. (0 - 120 Secs.)

• Calibrate Sensors ▶

• Thermostat (0°) ▶

The thermostat sensor may be calibrated -7 to +7 degrees F.

• Outdoor Sensor (0°) ▶

The outdoor sensor may be calibrated -7 to +7 degrees F.

• Test Outputs ▶

The installer or service technician can use this feature to test the functions without any time delays of the thermostat and heating and cooling equipment.

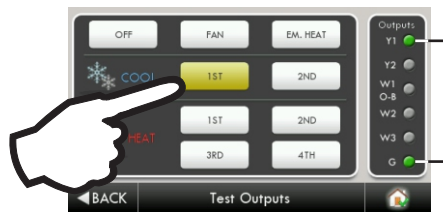

With a 1st stage cooling call, Y1 and G are active

## The Main Menu Buttons

Settings

### • Dealer Information ▶

The Dealer may enter their company contact information for the customer to use when they need service. This will appear in the "Who To Call For Service" button is pressed in the Information Menu.

Press the buttons below and use the keyboard to enter your information

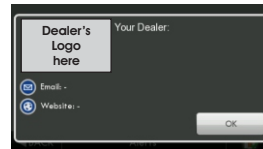

• Dealer Name ▶

• Contact Name ▶

• Dealer Phone ▶

• Dealer Email ▶

• Dealer Website ▶

Please use ColorTouch Assistant to add Dealer's logo. (See Page 40)

---

### • Factory Defaults ▶

Press to reset the thermostat back to the factory settings.

### • Delete Custom Images ▶

Press to delete the custom photos you uploaded to the thermostat.

### • Upgrade Firmware ▶

Press to upgrade the thermostat firmware. The SD Card must be in the thermostat SD Card reader and contain the valid firmware. If an error message appears, confirm with ColorTouch Assistant that firmware is up to date or simply try reinserting the SD card.

## The Main Menu Buttons

## Emergency Heat



Emergency Heat

The Emergency Heat function is only available if your thermostat is set to control a Heat Pump.

To initiate the Emergency Heat feature, Press the Emergency Heat button. During Emergency Heat operation the thermostat will turn on the fan and auxiliary stages of heat when there is a demand for heat. The 1st stage of heating and all stages of cooling will be unavailable. To exit Emergency Heat, press the Emergency Heat button.

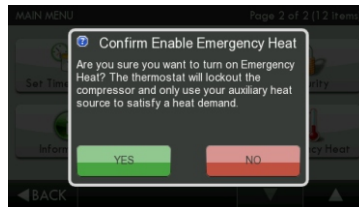

## ColorTouch Assistant

ColorTouch Assistant may be downloaded at no charge at:  
[www.venstar.com/Thermostats/ColorTouch/Assistant/](http://www.venstar.com/Thermostats/ColorTouch/Assistant/)



Every time the user runs the ColorTouch Assistant software, it automatically connects to Venstar's ColorTouch Web site in the background and updates the software and firmware (the operating system for ColorTouch) at no cost.

The ColorTouch Assistant allows you to use your computer to:

- Upload photos for background and slideshow images
- Program a time period schedule
- Upload dealer and service contact information and company logo
- Configure installation settings
- Update thermostat firmware

## The ColorTouch Assistant

### Uploading Photos and Settings to your thermostat

When you are finished adding and editing photos and settings, click on **Save to SD**. When prompted, remove the SD card from the SD card reader on your computer.



**Save to SD**

\*NOTE: SD cards with 20 MB minimum capacity required.

---

### At the thermostat:

Insert the SD card into the SD Card Slot.

Press **MENU** then 

Next, press 



**SD Card Slot**

Press 

Then, press 

Select the items to import to your thermostat then press **NEXT** 

Your thermostat will automatically save your new photos and settings.

## Installation Instructions

### Remove & Replace the Old Thermostat

To install the thermostat properly, please follow these step by step instructions. If you are unsure about any of these steps, call a qualified technician for assistance.

- ▶ Assemble tools: Flat blade screwdriver, wire cutters and wire strippers.



- ▶ Make sure your Heater/Air Conditioner is working properly before beginning installation of the thermostat.
- ▶ Carefully unpack the thermostat. Save the screws, any brackets, and instructions.
- ▶ Turn off the power to the Heating/Air Conditioning system at the main fuse panel. Most residential systems have a separate breaker for disconnecting power to the furnace.
- ▶ Remove the cover of the old thermostat. If it does not come off easily, check for screws.
- ▶ Loosen the screws holding the thermostat base or subbase to the wall and lift away.
- ▶ Disconnect the wires from the old thermostat. Tape the ends of the wires as you disconnect them, and mark them with the letter of the terminal for easy reconnection to the new thermostat.
- ▶ Keep the old thermostat for reference purposes, until your new thermostat is functioning properly.

## Installation Instructions

### Wire Connections

If the terminal designations on your old thermostat do not match those on the new thermostat, ***refer to the chart below or the wiring diagrams that follow.***

Wire from the old thermostat terminal marked	Function	Install on the new thermostat connector marked
G or F	Fan	G
Y1, Y or C	Cooling	Y1
W1, W or H	Heating	W1/O/B
Rh, R, M, Vr, A	Power	R
C	Common	C
O/B	Rev. Valve	W1/O/B*
W2	2nd Stage Heat	W2
Y2	2nd Stage Cooling	Y2
W3	3rd Stage Heat	W3
OUT -	Outdoor Sensor	OUTDOOR
OUT +	Outdoor Sensor	OUTDOOR

\* O/B is used if your system is a Heat Pump.

## Installation Instructions

### The Color Touch Thermostat Backplate

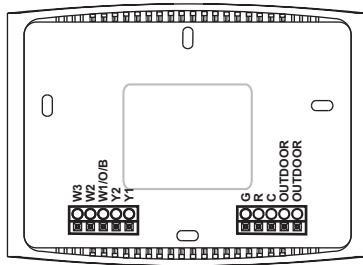

**To remove the thermostat backplate:**  
Using the Finger Pull Areas, pull the front housing away from the backplate.



Look for these tabs to locate the pull areas

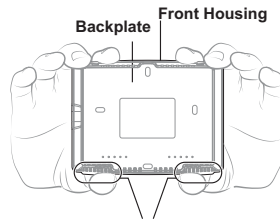

Pull out with thumbs in these areas

<b>W3</b>	3rd stage heat circuit	<b>G</b>	Fan relay
<b>W2</b>	2nd stage heat circuit	<b>R</b>	24 VAC return
<b>W1/O/B</b>	1st stage heat circuit	<b>C</b>	24 VAC common
<b>Y2</b>	2nd stage compressor relay	<b>OUTDOOR</b>	Outdoor sensor connections
<b>Y1</b>	1st stage compressor relay		

**IMPORTANT:** This thermostat requires ***both*** R (24 VAC Return) and C (24 VAC Common) be connected to the backplate terminals.

# Installation Instructions

## Explanation of Thermostat Dip Switches

Dip switches are located on the back of the thermostat

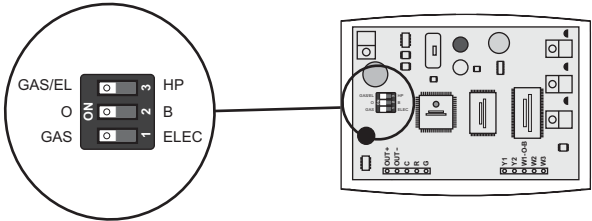

**GAS/EL HP    GAS/EL HP**

OR

This dip switch configures the thermostat to control a conventional gas/electric system or a heat pump. If your system is anything other than a heat pump, leave this switch set for GAS/EL.\*

*\*For some commercial heat pumps, this switch may need to be set for GAS/EL. Consult the commercial heat pump literature.*

**O B    O B**

OR

When the GAS/EL or HP dip switch is configured for HP, this dip switch (O or B) must be set to control the appropriate reversing valve. If O is chosen, the W1/O/B terminal will energize in cooling. If B is chosen, the W1/O/B terminal will energize in heating.

**GAS ELEC    GAS ELEC**

OR















**\*When GAS/EL or HP is set for GAS/EL:**  
This switch (GAS or ELEC) controls how the thermostat will control the Fan (G) terminal in heating mode. When GAS is chosen, the thermostat will not energize the Fan (G) terminal in heating. When ELEC is chosen the thermostat will energize the fan in heating.

**\*When GAS/EL or HP is set for HP:**  
This switch (GAS or ELEC) defines the Aux Heat type. When GAS is chosen, the auxiliary heat will not be allowed to run during heat pump operation. When using a Dual Fuel system, set this switch for GAS. When ELEC is chosen, up to two stages of auxiliary strip heat will be allowed to run.

## Installation Instructions

### Sample Wiring Diagrams with Dip Switch Positions

#### Conventional Heating and Cooling Systems

<p><b>3 Wire, Heat Only</b> Residential &amp; Commercial 1 Stage Heating with no Fan.</p> <p>R      24VAC Power C      24VAC Common W1/O/B   1st Stage Heat</p> <hr/> <p>GAS/EL    HP O    B GAS    ELEC</p>	<p><b>4 Wire, Cool Only</b> Residential &amp; Commercial 1 Stage Cooling.</p> <p>R      24VAC Power C      24VAC Common Y1      1st Stage Cool G      Fan</p> <hr/> <p>GAS/EL    HP O    B GAS    ELEC</p>
<p><b>5 Wire, 1 Stage Cooling, 1 Stage Heat</b> Residential &amp; Commercial 1 Stage Cooling, with 1 stage Gas Heat.</p> <p>R      24VAC Power C      24VAC Common W1/O/B   1st Stage Heat Y1      1st Stage Cool G      Fan</p> <hr/> <p>GAS/EL    HP O    B GAS    ELEC</p>	<p><b>5 Wire, 1 Stage Cooling, 1 Stage Heat</b> Residential &amp; Commercial 1 Stage Cooling, with 1 stage Electric Heat.</p> <p>R      24VAC Power C      24VAC Common W1/O/B   1st Stage Heat Y1      1st Stage Cool G      Fan</p> <hr/> <p>GAS/EL    HP O    B GAS    ELEC</p>
<p><b>8 Wire, 2 Stage Cooling, 3 Stage Heat</b> Residential &amp; Commercial 2 Stage Cooling, with 3 stage Gas Heat.</p> <p>R      24VAC Power C      24VAC Common W1/O/B   1st Stage Heat W2      2nd Stage Heat W3      3rd Stage Heat Y1      1st Stage Cool Y2      2nd Stage Cool G      Fan</p> <hr/> <p>GAS/EL    HP O    B GAS    ELEC</p>	

## Installation Instructions

### Sample Wiring Diagrams with Dip Switch Positions

#### Heat Pump Systems

**5 Wire, 1 Stage Cooling, 1 Stage Heat**  
Residential & Commercial Heat Pump with 'O' Reversing Valve

R	24VAC Power
C	24VAC Common
W1/O/B	Reversing Valve
Y1	1st Stage Compressor (Cool or Heat)
G	Fan

GAS/EL		HP
O		B
GAS		ELEC

**6 Wire, 1 Stage Cooling, 2 Stage Heat**  
Residential & Commercial Heat Pump with 'O' Reversing Valve

R	24VAC Power
C	24VAC Common
W1/O/B	Reversing Valve
Y1	1st Stage Compressor (Cool or Heat)
W2	Aux Heat
G	Fan

GAS/EL		HP
O		B
GAS		ELEC

**7 Wire, 2 Stage Cooling, 3 Stage Heat**  
Residential & Commercial Heat Pump with 'O' Reversing Valve.

R	24VAC Power
C	24VAC Common
W1/O/B	Reversing Valve
W2	3rd Stage Heat
Y1	1st Stage Compressor (Cool or Heat)
Y2	2nd Stage Compressor (Cool or Heat)
G	Fan

GAS/EL		HP
O		B
GAS		ELEC

(Number of Compressor Stages set to 2)

**8 Wire, 2 Stage Cooling, 4 Stage Heat**  
Residential & Commercial Heat Pump with 'O' Reversing Valve.

R	24VAC Power
C	24VAC Common
W1/O/B	Reversing Valve
W2	3rd Stage Heat
W3	4th Stage Heat
Y1	1st Stage Compressor (Cool or Heat)
Y2	2nd Stage Compressor (Cool or Heat)
G	Fan

GAS/EL		HP
O		B
GAS		ELEC

(Number of Compressor Stages set to 2)

## Installation Instructions

### Sample Wiring Diagrams with Dip Switch Positions

#### Heat Pump Systems with Dual Fuel

<b>7 Wire, 2 Stage Cooling, 3 Stage Heat</b>		Residential & Commercial Heat Pump with 'O' Reversing Valve and Fossil Fuel furnace.	
R	24VAC Power	GAS/EL	HP
C	24VAC Common	ON	B
W1/O/B	Reversing Valve	OFF	ELEC
W2	3rd Stage Heat (connected to furnace)	Number of Compressor Stages set to 2 (see <i>Compressor Stages</i> , pg. 33)	
Y1	1st Stage Compressor (Cool or Heat)		
Y2	2nd Stage Compressor (Cool or Heat)	Dual Fuel set to On (see <i>Dual Fuel Settings</i> , pg. 36)	
G	Fan		

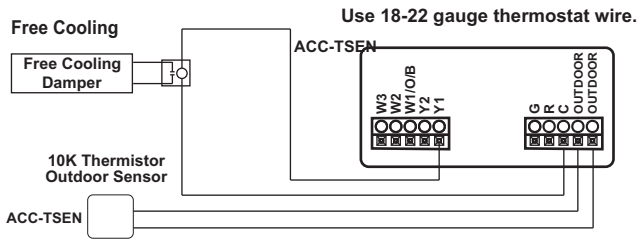

Free Cooling utilizes the Y1 terminal for the operation of 1st stage cooling. If mechanical (compressor) cooling is also present, the mechanical cooling is connected to the Y2 terminal in this instance.

Free Cooling may be used with a Gas/Electric or Heat Pump system.

**Outdoor Sensor: ACC-TSEN Temperature Sensor** 10K ohm sensor at 77F/25C. Negative Temperature Coefficient.

## Troubleshooting

- ▶ **SYMPTOM:** The air conditioning does not attempt to turn on.  
**CAUSE:** The compressor timer lockout may prevent the air conditioner from turning on for a period of time.  
**REMEDY:** Adjust the Compressor Min. Off Time to “None”.
- ▶ **SYMPTOM:** The display is blank.  
**CAUSE:** Lack of proper power.  
**REMEDY:** Make sure the power is on to the furnace and that you have 24vac between **R & C**.
- ▶ **SYMPTOM:** The air conditioning does not attempt to turn on.  
**CAUSE:** The cooling setpoint is set too high.  
**REMEDY:** Lower the cooling setpoint or lower the cooling setpoint limit. See Setpoint Limits (page 25).
- ▶ **SYMPTOM:** The heating does not attempt to turn on.  
**CAUSE:** The heating setpoint is set too low.  
**REMEDY:** Raise the heating setpoint or raise the heating setpoint limit. See Setpoint Limits (page 25).
- ▶ **SYMPTOM:** When controlling a residential heat pump, and asking for cooling, the heat comes on.  
**CAUSE:** The thermostat reversing valve dip switch is set for “**B**”.  
**REMEDY:** Set the reversing valve dip switch for “**O**”.
- ▶ **SYMPTOM:** When calling for cooling, both the heat and cool come on.  
**CAUSE:** The thermostat equipment dip switch is configured for “**HP**” and the HVAC unit is a Gas/Electric.  
**REMEDY:** Set the equipment dip switch for “**Gas**”.

## Index

### A

**Active Brightness, 17**  
**Alerts, 14**  
view current, 15  
reset, 15  
set/edit reminders, 15  
*See also Runtime*  
**Aux Heat Lockout, 36**  
**Auto**  
adjust temperature, 3  
changeover, 3  
fan, 3  
mode, 3  
**Auto Screenlock, 25**  
**Available Modes, 31**

### B

**B Reversing Valve, 45**  
**Backdrop, 20**  
**Backlight, 17**  
**Backplate, 44**  
**Balance Point, 36**  
**Beep, 20**  
**Buttons,**  
Back, 1  
Cooler, 1, 3  
Fan, 1, 3  
Home, 1  
Mode, 1, 3  
Menu, 1, 7  
Warmer, 1

### C

**C, 44**  
**Calibration, 37**  
**Celsius, 31**  
**Cleaning, 2, 18**  
**Clock**  
Display, 1  
Setting, 5  
**ColorTouch Assistant, 40**  
**Compressor Lockout, 33**  
**Cool**  
1st stage deadband,  
*see Deadband*  
2nd stage deadband,  
*see Deadband*  
Minutes of runtime, 27  
**Custom Wallpaper, 20**  
**Cycles Per Hour, 33**

### D

**Daylight Savings, 6**  
**Deadband**  
1st stage, 34  
2nd stage, 34  
3rd stage, 34  
4th stage, 34

**Dealer Information, 27, 38**

**Delay**  
Fan-off, *see Fan*  
Time between stages,  
*see Time Delay*

**Differential**  
Heat and cool, 33

**Dimmer, 17**

**Dip Switches**  
ELEC, 45  
electric heat, 45  
GAS/EL, 45  
GAS, 45  
HP, 45  
heat pump, 45  
O, 45  
B, 45

**Disabled Buttons**  
*see Security*

**Display, 17**

**Dual Fuel**  
changeover balance  
point, 36  
control two heat  
sources, 36  
operation, 36  
outdoor sensor, 36, 48

### E

**Electric Heating**  
Aux heat, 33  
Dip switch setting, 45  
Lockout, 36

## Index

### Emergency Heat, 39

**Energy Watch**  
Cool, 27  
Heat, 27  
Aux heat, 27

## F

**Factory Defaults**  
resetting, 38

**Fahrenheit, 31**

### Fan

button function, see  
*Buttons*  
off time delay, 37  
on during heat, see  
*Electric Heat*  
runtime, 27  
2nd stage heat, see  
*Emergency Heat*

**Free Cooling, 35, 48**

## G

**Gas/Electric Furnace**  
dip switch, 45

**General Setup, 31**

## H

### Heat

1st stage  
deadband, see  
*Deadband*  
emergency heat, 39  
minutes of runtime, 27  
2nd stage  
deadband, see  
*Deadband*  
electric strip heat,  
see *Aux Heat*  
minutes of runtime, 27  
3rd stage  
deadband, see  
*Deadband*  
4th stage  
deadband, see  
*Deadband*  
timer, 34  
turnoff point, 34  
electric/heat pump, 36  
mode, 3  
program, see *Schedule*  
runtime, see *Runtime*  
setpoint, 3

**Heat/Cool Indicator, 20**

### Heat Pump

aux heat, 33, 36  
aux heat lockout, 36  
emergency heat, 39  
heat pump lockout, 36  
dip switch setting, 45  
multi-stage, 33, 36

## I

**Idle Brightness, 17**

**Information, 27**

**Installation Settings, 33**

**Installation, 42**

## K

**Keypad, 25**

## L

**Language, 32**

**Lock**

see *Security*

**Logo, 38**

## Index

### M

**Main Menu**, 1, 7  
**Maintenance**, 18  
**Manual**  
  changeover, 32  
  cool, 3  
  heat, 3  
**Mode**, 1, 3  
**Mode Restrictions**, 25  
**Morning Warm-up**,  
  see *Smart Recovery*  
**Multi-Stage**  
**Operation**, 3

### N

**Night Dimmer**, 17  
**Non-Programmable**  
**Thermostat**, ii

### O

**O Reversing Valve**, 45  
**Off Mode**, 3  
**Outdoor**  
  calibrate, 37  
  high and low temp, 1  
  sensor, 48  
  viewing temp, 1

### P

**Passcode**, 25  
**Photos**, 20, 41  
**Preferences**, 20  
**Program**  
  daily schedule, 8

### R

**Reset**  
  alert messages, 15  
  thermostat settings,  
  see *Factory Defaults*  
  runtime,  
  fan/filter, 15  
  UV light, 15  
**Reversing Valve**, 45, 47  
**Runtime**  
  resetting, see *Reset*  
  service filter, 15  
  UV light, 15  
  viewing, 15, 27

### S

**Schedule**  
  turn on/off, 8  
  view, 8  
  edit, 8

**Screen Cleaning**, 18

**Screensaver**  
  turn on/off, 13  
  setup, 13  
  preview, 13  
**SD Card**, 31  
**2nd stage turn off**  
**temperature**, 34  
**Security**, 25

**Sensor**  
  outdoor,  
  thermostat,  
**Service**  
  alerts, 15  
  information, 15, 27  
**Set Clock**, see *Clock*

**Setpoint**  
  balance point, 36  
  cool, 3  
  heat, 3  
  limits, 25  
  vacation, 23  
**Settings**, 30  
**Simple Thermostat**, 32  
**Smart Fan**, 11  
**Smart Recovery**, 32  
**Sound Options**, 20  
**Stages**, 33

### T

**Terminals**, see  
  *Backplate*  
**Test Outputs**, 37

## Index

**Themes, 30**

**Thermostat Sensor**  
calibrate, 37

**Three Stage Heat, 33**

**Time, see Clock**

**Timers, 33**

**Time Delay,**  
compressor lockout, 33  
cycles per hour, 33  
1st stage to 2nd stage, 34  
2nd stage to 3rd stage, 34  
3rd stage to 4th stage, 34

**Time schedule, see**  
*Schedule*

**Touch Calibration, 18**

## U

**Upgrade Firmware, 38**

**User Interface Themes, 30**

**UV Light,**  
resetting, 15  
runtime, see *Runtime*  
setting, see *Runtime*

## V

**Vacation, 22**

modes, 23  
schedule, 22  
setpoints, 23

## W

**W1, 44**

**W2, 44**

**W3, 44**

**Wallpaper, 20**

**Warranty, 56**

**Wiring, 46**  
dual fuel, 48  
free cooling, 48  
gas/electric, 46  
heat pump, 47

## Y

**Y1, 35, 44**

**Y2, 35, 44**

**Notes:**

**Notes:**

## Warranty

One-Year Warranty - This Product is warranted to be free from defects in material and workmanship. If it appears within one year from the date of original installation, whether or not actual use begins on that date, that the product does not meet this warranty, a new or remanufactured part, at the manufacturer's sole option to replace any defective part, will be provided without charge for the part itself provided the defective part is returned to the distributor through a qualified servicing dealer.

THIS WARRANTY DOES NOT INCLUDE LABOR OR OTHER COSTS incurred for diagnosing, repairing, removing, installing, shipping, servicing or handling of either defective parts or replacement parts. Such costs may be covered by a separate warranty provided by the installer.

THIS WARRANTY APPLIES ONLY TO PRODUCTS IN THEIR ORIGINAL INSTALLATION LOCATION AND BECOMES VOID UPON REINSTALLATION.

LIMITATIONS OF WARRANTIES – ALL IMPLIED WARRANTIES (INCLUDING IMPLIED WARRANTIES OF FITNESS FOR A PARTICULAR PURPOSE AND MERCHANTABILITY) ARE HEREBY LIMITED IN DURATION TO THE PERIOD FOR WHICH THE LIMITED WARRANTY IS GIVEN. SOME STATES DO NOT ALLOW LIMITATIONS ON HOW LONG AN IMPLIED WARRANTY LASTS, SO THE ABOVE MAY NOT APPLY TO YOU. THE EXPRESSED WARRANTIES MADE IN THIS WARRANTY ARE EXCLUSIVE AND MAY NOT BE ALTERED, ENLARGED, OR CHANGED BY ANY DISTRIBUTOR, DEALER, OR OTHER PERSON WHATSOEVER.

ALL WORK UNDER THE TERMS OF THIS WARRANTY SHALL BE PERFORMED DURING NORMAL WORKING HOURS. ALL REPLACEMENT PARTS, WHETHER NEW OR REMANUFACTURED, ASSUME AS THEIR WARRANTY PERIOD ONLY THE REMAINING TIME PERIOD OF THIS WARRANTY.

THE MANUFACTURER WILL NOT BE RESPONSIBLE FOR:

1. Normal maintenance as outlined in the installation and servicing instructions or owner's manual, including filter cleaning and/or replacement and lubrication.
2. Damage or repairs required as a consequence of faulty installation, misapplication, abuse, improper servicing, unauthorized alteration or improper operation.
3. Failure to start due to voltage conditions, blown fuses, open circuit breakers or other damages due to the inadequacy or interruption of electrical service.
4. Damage as a result of floods, winds, fires, lightning, accidents, corrosive environments or other conditions beyond the control of the Manufacturer.
5. Parts not supplied or designated by the Manufacturer, or damages resulting from their use.
6. Manufacturer products installed outside the continental U.S.A., Alaska, Hawaii, and Canada.
7. Electricity or fuel costs or increases in electricity or fuel costs for any reason whatsoever including additional or unusual use of supplemental electric heat.
8. ANY SPECIAL INDIRECT OR CONSEQUENTIAL PROPERTY OR COMMERCIAL DAMAGE OF ANY NATURE WHATSOEVER. Some states do not allow the exclusion of incidental or consequential damages, so the above may not apply to you.

This warranty gives you specific legal rights and you may also have other rights which may vary from state to state.



Printed on recycled paper.  
P/N 88-860 Rev. 4